



BigBattery

Your Source For Power

12V, 24V & 48V HUSKY 2 INV USER MANUAL (Inverter Version)



APPLIES TO:

48V HUSKY 2 (SKU: FHSKY-48051-G2-INV)

24V HUSKY 2 (SKU: FHSKY-24051-G2-INV)

12V HUSKY 2 (SKU: FHSKY-12051-G2-INV)

Version 1.8

© 2025 BIGBATTERY, LLC. ALL RIGHTS RESERVED
VERSION 1.7 | INFORMATION SUBJECT TO CHANGE WITHOUT NOTICE
MODEL SKU: FHSKY-48051-G2-INV, FHSKY-24051-G2-INV & FHSKY-12051-G2-INV



SCAN THE QR CODE FOR
THE LATEST VERSION

Table of Contents

1. Definition of Terms.....	3
2. Safety Instructions.....	4
3. Introduction.....	6
3.1. Product Description.....	6
3.2. Features & Applications.....	7
4. Packed Components.....	7
4.1. 12V HUSKY 2.....	7
4.2. 24V HUSKY 2.....	8
4.3. 48V HUSKY 2.....	8
5. Product Specifications.....	9
5.1. Battery Overview.....	9
5.2. Battery Specs.....	10
5.3. Battery Diagram.....	11
5.4. Battery Communication Ports.....	12
5.5. Battery LED Indicators.....	12
6. Installation.....	13
6.1. Installation Safety Guidelines.....	13
6.2. Battery Installation.....	13
7. Battery Commissioning.....	17
7.1. Battery Configuration.....	17
7.2. Supported Inverters.....	19
8. Battery Operation Guide.....	20
8.1. Charging.....	20
8.2 Discharging.....	20
8.3 State of Charge.....	21
8.3 Storage.....	21
8.4 Extend the life of your Battery.....	22
9. Service.....	23
9.1 Troubleshooting.....	23
9.2 Maintenance.....	24
10. Recycling.....	25
11. Warranty & Returns.....	25

1. Definition of Terms

- AWG – American Wire Gauge
- A – Amp(s)
- Ah – Amp hour(s)
- AC – Alternating Current
- Battery Module – Single battery
- Battery System – Two or more battery modules connected to a controller box
- BMS – Battery Management System
- Capacity – Measure of stored energy, typically in Ah or mAh
- Controller Box – Master BMS Unit
- Cell Balancing – Process of ensuring uniform charge among cells in a battery
- Cycle Life – Total charge-discharge cycles before capacity decline
- C-rating – Charging/discharging rate relative to battery capacity
- DC – Direct Current
- DOD – Depth of Discharge
- ESS – Energy Storage System
- kW – Kilowatt(s)
- kWh – Kilowatt-hour(s)
- LFP – Lithium Iron Phosphate or LiFePO₄
- mm – Millimeter(s)
- mV – Millivolt(s)
- Overcharge – Charging beyond recommended voltage limits
- PPE – Personal Protective Equipment
- PV – Photovoltaic
- Self-Discharge – Natural battery discharge over time
- State of Charge (SOC) – Battery's remaining charge as a percentage
- State of Health (SOH) – Overall battery condition and performance
- Thermal Runaway – Dangerous overheating with potential battery damage
- V – Volt(s)











2. Safety Instructions

Before you start working, make sure to read and follow all safety instructions for handling the battery. When installing it, be sure to meet all the rules and regulations in your area. Ask your local authority for the right permits and approvals before you install it.



















Lithium Iron Phosphate (LiFePO₄) batteries are an inherently safe chemistry. However, safety measures should always be taken as consideration before, during, and after installation and during ongoing use and maintenance. The following safety notices are crucial for both the installer and end users when operating this product normally.

Improper installation could result in harm to the installer, the operator, or others, as well as damage to the battery or connected equipment.

WARNING:

-  Do not make any connections or disconnections to the system when the batteries are in operation. Working with active batteries can lead to system component damage or pose a risk of electrical shock.
-  Do not charge with a charge voltage above the specified on section 5.2.
-  Do not charge nor discharge battery when ambient temperature is above **55 °C (131 °F)**.
-  Do not install battery where it may contact conductive materials, water, seawater, strong oxidizers, nor strong acids.
-  Do not install battery in a location exposed to direct sun, hot surfaces, nor hot locations. Do not install batteries in a tight clearance compartment, overheating may result.
-  Keep any flammable/combustible material (e.g. paper, cloth, plastic, etc.) that may be ignited by heat, sparks, flames, or any other heat source at a minimum distance of two feet away from the batteries.
-  Disconnect batteries immediately if, during operation or charging, they emit an unusual smell, develop heat, or behave abnormally.
-  Have a Class ABC or Class BC fire extinguisher on the premises.
-  Never short-circuit DC inputs: may result in a risk of electric shock or fire.
-  Do not disassemble the battery: Contact BigBattery for proper handling instructions. Incorrect servicing or re-assembly may result in a risk of electric shock or fire and voiding the warranty

PRECAUTION:

-  Qualified personnel must handle all product work to reduce the risk of electric shock.
-  Follow local and national electrical standards for installation and confirm utility provider and local authorities requirements before grid connection.
-  Maintain visibility of warning labels and nameplates.
-  Choose battery placement with future user safety in mind.
-  Keep children away from the battery and systems.
-  Use team lift technique due to battery weight.
-  Use batteries as directed; do not open or modify.
-  Avoid inserting foreign objects into battery terminals.
-  Handle batteries and/or battery-powered devices cautiously when using metal tools or when around the system. Risk of electrical arcs or short-circuits can cause serious harm, death, and equipment damage.
-  Do not charge or discharge the battery if ambient temperature is below **-20** °C (**-4** °F).
-  Beware of the battery current: Please ensure that the battery is “off” before installing or working on the battery. Use a voltmeter to confirm there is no voltage present.
-  Always wear protective gear when handling batteries (PPE).
-  Handle batteries carefully to prevent damage; avoid pulling, dragging, or mishandling.
-  Inspect batteries before use; don't use damaged or swollen ones; contact BigBattery immediately.
-  Don't paint any part of the batteries, inside or out.
-  Make sure all cable connections are properly tightened and secured, and to prevent any accident caused by improper installation.
-  Install and remove batteries using the handles provided.
-  Do not place any objects on top of batteries.
-  Before storing battery for more than 6 months, fully charge the battery and disconnect batteries from your system.

Disclaimer:

BigBattery, Inc has the authority to modify the content here without prior notice. To access the latest manual version, please visit our website at www.bigbattery.com.

3. Introduction

Introducing BigBattery's HUSKY 2! These revolutionary lithium battery systems designed to push the boundaries of efficiency, flexibility, and reliability in energy management are the BEST Batteries Money can Buy. The HUSKY 2 represents a leap forward in energy storage technology, offering a compact and scalable solution for seamlessly integrating renewable energy sources into your home, business, or mobile applications. With its cutting-edge features and intelligent design, this advanced lithium battery system promises to empower individuals and organizations to take control of their energy usage like never before. Equipped with one of our HUSKY 2 battery systems from BigBattery, you'll stay powered and prepared!

This User Manual is designed to provide you with an understanding of the specs, features, capabilities, and installation of these batteries. Read and take note of all safety information prior to installing or operating your battery. This document applies to the 48V (FHSKY-48051-G2-INV), 24V (FHSKY-24051-G2-INV) and 12V (FHSKY-12051-G2-INV) HUSKY 2 battery system.

3.1. Product Description

The 48V, 24V and 12V 5kWh HUSKY 2 battery systems are ideal for low-voltage applications and for your RV's, solar systems, off-grid power systems, emergency power supplies, and more. Each single battery module is 5.12kWh and it can be expanded up to 80 kWh when connecting in parallel. These batteries utilize lithium iron phosphate (LiFePO₄ or LFP) cells, renowned for their top-notch safety.

They are water resistant and equipped with an intelligent Battery Management System (BMS) that continuously monitors and records cell voltage, along with real-time data on current, voltage, and temperature for the module. The BMS features a passive balance function and an advanced battery control method, which collectively enhance battery pack performance. Furthermore, the battery includes built-in fire-extinguishing modules for added safety. It has built-in heating elements so the battery can be charged in freezing environments and temperatures. The battery utilizes a standard M8 bolt connection, which easily and safely secures power to your battery unit. Designed to endure, the HUSKY 2 has a lifespan of over 10 years and is engineered to withstand more than 4000 - 6000 cycles at 80% Depth of Discharge (DOD) at a rate of 0.5 C.

You can always monitor the batteries' capacity with the LED meter or check the battery's health and performance from your phone with the bluetooth BigBatteryApp, which will display information of the condition of your battery.

3.2. Features & Applications

Applications:

- Homes
- Cabin Off-Grid
- Solar
- (ESS)
- Backup Power
- RVs
- Boats

Features:

- Advanced BMS (Battery Management System)
- Lithium-Ion LiFePO4/LFP Chemistry
- Easy connection to a larger power system
- Expandable system with easy parallel connections
- Multiple layers of safety and battery protection
- Built-in heating system
- Built-in fire suppression system
- Impact Resistant
- Water resistant
- Good insulation performance
- High quality & durable ABS construction
- Utilizes standardized M8-bolt connector for battery power source.
- Parallel Communication
- CAN bus and RS-485 communication with different inverters.
- RJ-45 ports
- LED SOC Meter
- Mobile Monitor Application

4. Packed Components

4.1. 12V HUSKY 2

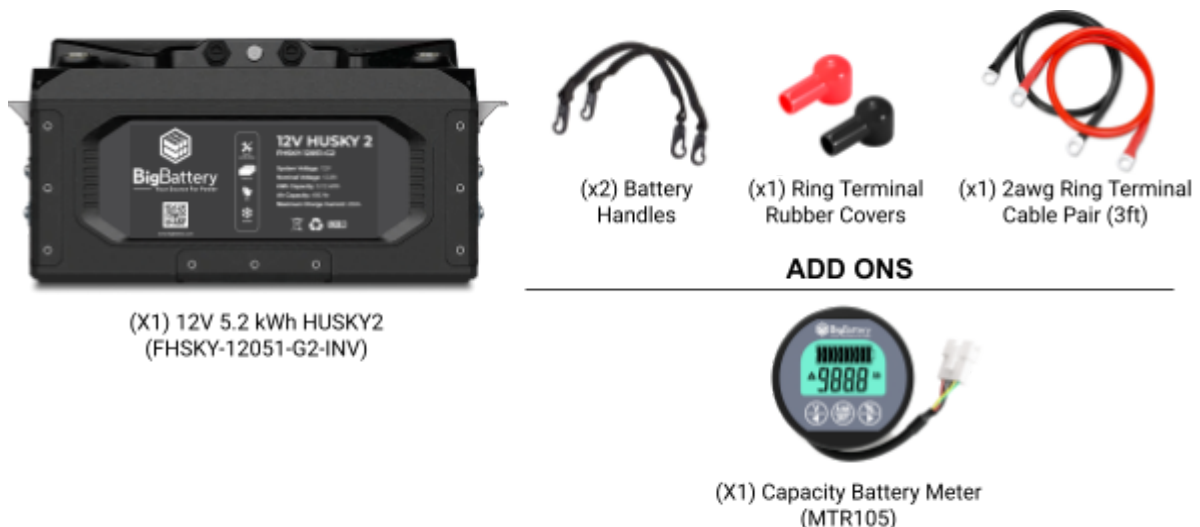

4.2. 24V HUSKY 2



(X1) 24V 5.2 kWh HUSKY2
(FHSKY-24051-G2-INV)



(x2) Battery
Handles



(x1) Ring Terminal
Rubber Covers



(x1) 2awg Ring Terminal
Cable Pair (3ft)

ADD ONS



(X1) Capacity Battery Meter
(MTR105)

4.3. 48V HUSKY 2



(X1) 48V 5.2 kWh HUSKY2
(FHSKY-48051-G2-INV)



(x2) Battery
Handles



(x1) Ring Terminal
Rubber Covers



(x1) 2awg Ring Terminal
Cable Pair (3ft)

ADD ONS



(X1) Capacity Battery Meter
(MTR105)

5. Product Specifications

5.1. Battery Overview

Figure 1: HUSKY2 Battery Overview

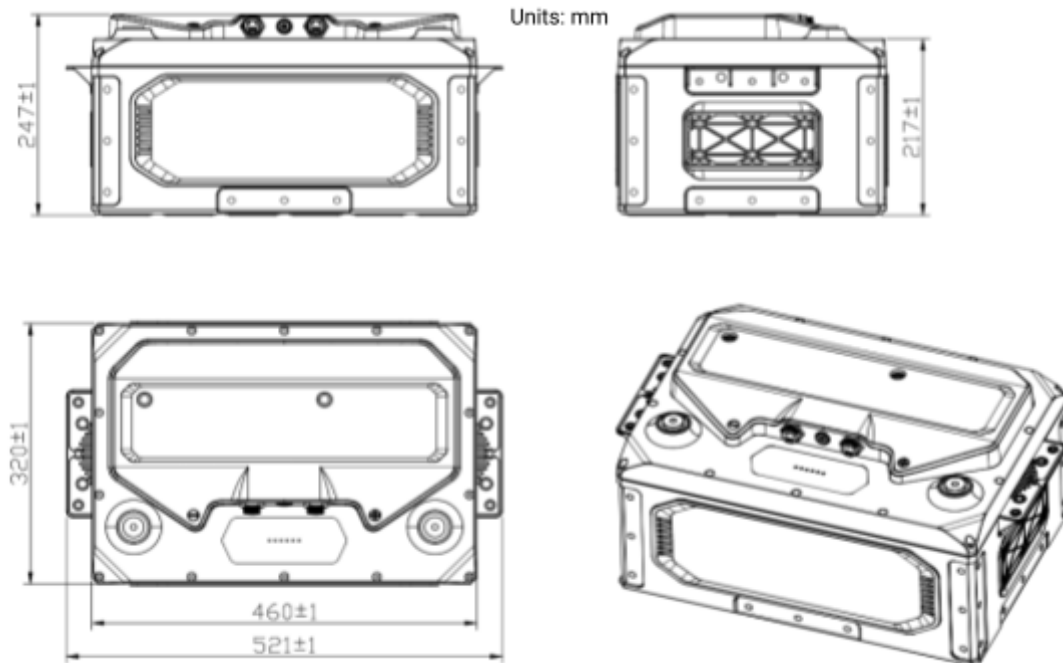

Before handling the battery, always switch it off and verify there is no voltage with a voltmeter to prevent accidental contact with live terminals. Failure to do so could lead to severe injury or fatality.

5.2. Battery Specs

BATTERY SPECIFICATIONS



12V



24V



48V

SKU	FHSKY-12051-G2-INV	FHSKY-24051-G2-INV	FHSKY-48051-G2-INV
System Voltage	12V	24V	48V
Nominal Voltage	12.8V	25.6V	51.2V
Chemistry	LiFePO4	LiFePO4	LiFePO4
kWh Capacity	5.12 kWh	5.12 kWh	5.12 kWh
Ah Capacity	400 Ah	200 Ah	100 Ah
Charging Voltage Range	13.9V - 14V	27.8V - 28V	55.6V - 57V
Max Charge Voltage	14.4V	29.2V	57.6V
Operating Voltage Range	12V - 14.4V	24V - 28.8V	48V - 57V
Suggested Low Voltage Cutoff	12V - 12.7V	24V - 25.4V	48V - 50.8V
BMS Cutoff Range	10.5V - 11.75V	21V - 23.5V	42V - 47V
Cell Configuration	4S	8S	16S
Max Cont. Discharge Current	250A	200A	100A
Max Continuous Power	5120W	5120W	7500W
Max Discharge Peak Current	500A (Max 3 seconds)	500A (Max 5 seconds)	150A (Max 3 seconds)
Max Charge Current	200A	150A	100A
Charge Temperature Range	-4°F - 113°F	-4°F - 113°F	-4°F - 113°F
Discharge Temperature Range	-4°F - 131°F	-4°F - 131°F	-4°F - 122°F
Optimal Discharge Temp. Range	59°F - 95°F	59°F - 95°F	59°F - 95°F
Storage Temp. Range (SoC >50%)	-4°F - 113°F (Max 6 months)	-4°F - 113°F (Max 6 months)	-4°F - 122°F (Max 6 months)
Dimensions (DxWxH)	12.6 x 18.1 x 9.8 in (320 x 460 x 249 mm)	12.6 x 18.1 x 9.8 in (320 x 460 x 249 mm)	12.6 x 18.1 x 9.8 in (320 x 460 x 249 mm)
Weight	100 lbs (45.4 kg)	100 lbs (45.4 kg)	100 lbs (45.4 kg)
Max Connections	Up to (16) Parallel	Up to (16) Parallel	Up to (16) Parallel
Protection Rating	IP65 / NEMA 4X	IP65 / NEMA 4X	IP65 / NEMA 4X
Communications	CANBus / RS485	CANBus / RS485	CANBus / RS485
Heating Function	Yes	Yes	Yes

Last Revision Date: 05/01/2025

Need Further Assistance?

Email us @ Support@BigBattery.com (OR) Call us @ # (818) 280-3091.

5.3. Battery Diagram

Figure 2: HUSKY2 Battery Diagram



Item	Name	Description	Details
1	BAT-	Negative Battery Terminal	M8 Screw
2	BAT+	Positive Battery Terminal	M8 Screw
3	SOC	Battery State of Charge LEDS Indicators	4 LEDS On = 100% 3 LEDS On = 75% 2 LEDS On = 50% 1 LED On = 25%
4	Alarm	Alarm LED Indicator	
5	On LED	ON/Operating LED Indicator	
6	RS485/CAN	RJ45 Communication Port	RS485/CAN
7	On/Off Button	Button Switch On/Off the BMS	

5.4. Battery Communication Ports

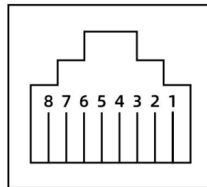

Pin	Description
1	RS485 B-(T/R-)
2	RS485 A+(T/R+)
3	-
4	CAN-H
5	CAN-L
6	-
7	RS485 A+(T/R+)
8	RS485 B-(T/R-)

Note: Both RJ45 Communication Port can be used for RS485 or CAN protocols.

5.5. Battery LED Indicators

Status	Operation	RUN *	Alarm *	SOC ****	Notes
Shutdown / Sleep		OFF	OFF	OFF	
Stand by	Normal	ON	OFF	4 LEDS On = 100% 3 LEDS On = 75% 2 LEDS On = 50% 1 LED On = 25%	-
Charge	Normal	Flash 1	OFF		Flash 1 OFF: 1.0S ON : 1.0S
	Alarm	Flash 1	OFF		
	End-Off Voltage	ON	OFF		
Discharge	Over-Temp / Over-Current Protection	OFF	ON		
	Normal	Flash 2	OFF		Flash 2 OFF: 0.5 S ON: 0.5 S
	Alarm	Flash 2	OFF		
	End-Off Voltage	OFF	ON		

	Over-Temp / Over-Current Protection	OFF	ON		
--	---	-----	----	--	--

6. Installation

 **WARNING:** Before installing, make sure to review all warnings and precautions in Section 2, as well as the installation safety guidelines in Section 6.1 below.

6.1. Installation Safety Guidelines

- Inspect batteries upon receipt for any signs of damage before use. In case of battery damage, reach out to BigBattery for repair or replacement. Avoid using a defective battery as it may result in incorrect battery voltage that could potentially ruin your appliances. Damaged batteries have the potential to cause fire hazards.
- Check to ensure that all cables are in good condition.
- Be sure your battery packs are powered “**OFF**” before making/removing any connections.
- It is crucial to never create a short circuit on the external battery terminals. When attaching the battery, ensure that each cable is properly connected to the correct terminal. There should be no conductive material between the terminals that could cause a short circuit.
- Use a screwdriver with a rubber coated handle.
- **Do not put the HUSKY2 batteries in series.** The BMS and internal components are not designed to handle this setup, which could cause the modules to fail.
- Always mount the battery in an upright position.

6.2. Battery Installation

- ① Place the battery on a flat floor or shelf.
- ② To secure the battery, first remove the "handles" from the case. The included L-bracket can then be repurposed as a floor mounting bracket by attaching it to the bottom of the battery and securing it to the floor using an electric drill. Alternatively, when positioned on the side of the battery, the L-bracket serves as a wall mounting bracket for vertical installation. L-brackets can be mounted on the left, right, or bottom edges of any side of the battery, providing flexible mounting options for floor or wall placement depending on the battery's orientation.

Important: The battery can be safely positioned on any of its sides except with the top side facing downward, as illustrated in Figure 3.

Figure 3: Single HUSKY2 Mounting Installation

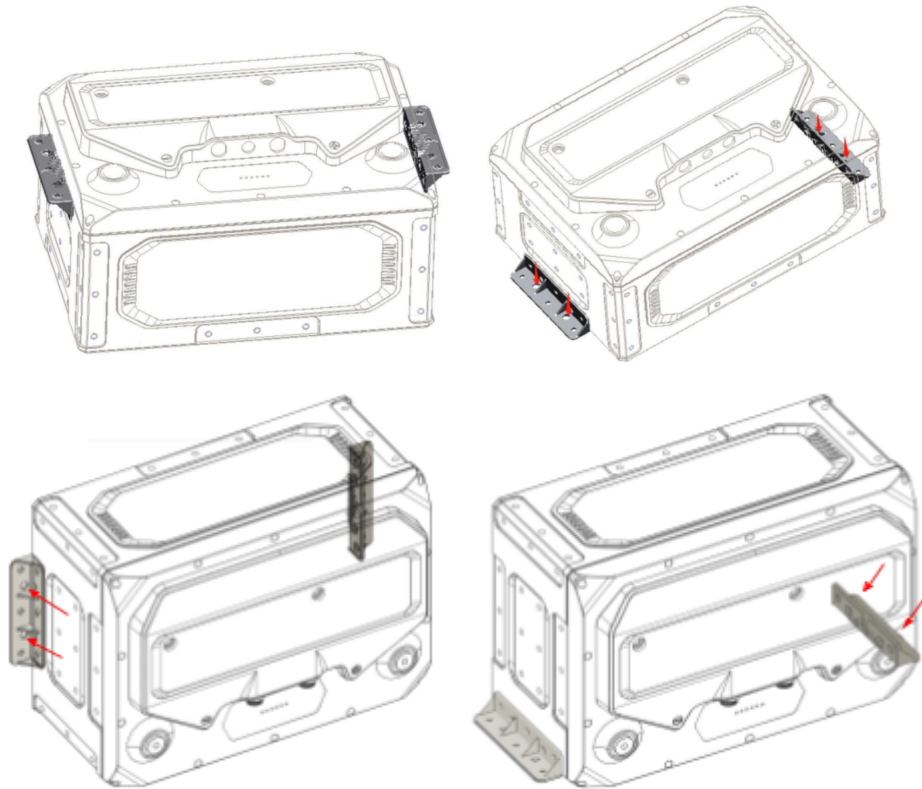

- ③ When connecting several batteries in parallel, you can utilize the rectangular metal strip as a linking plate, and secure the batteries together using an electric wrench, as shown in figure 4.

Figure 4: HUSKY2 Mounting Batteries in Parallel

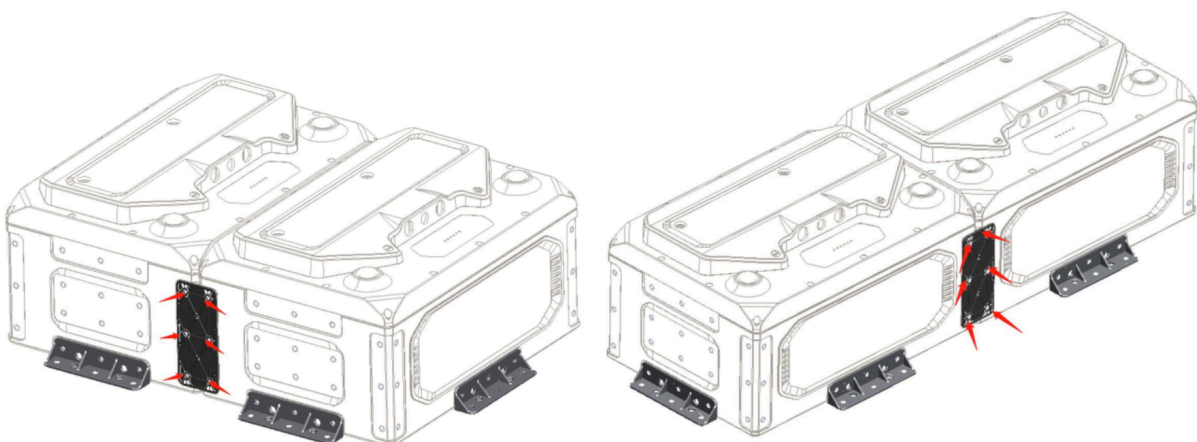

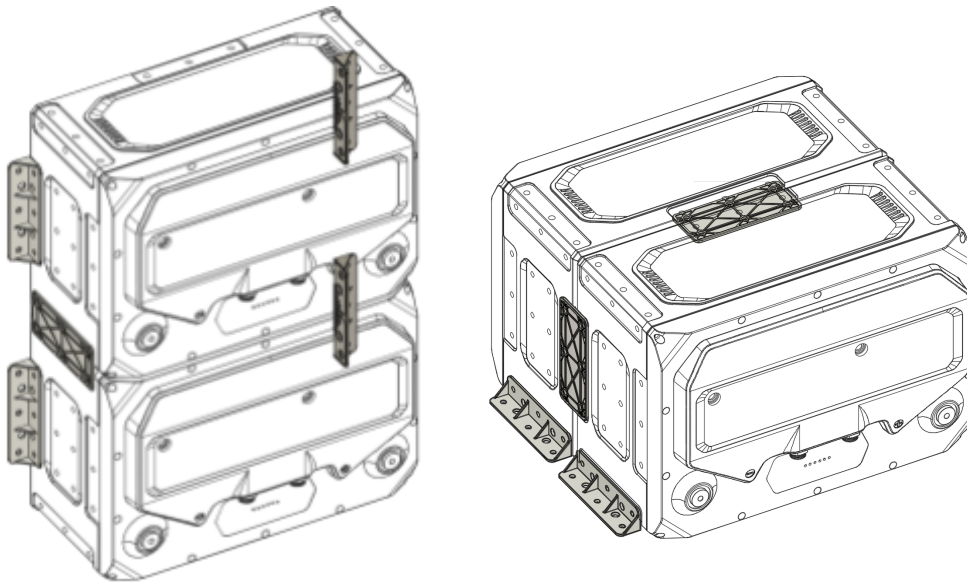

- ④ When using a single battery, connect it directly to the inverter for both power and communication, and set its ID to 1. For systems with multiple batteries in parallel, designate one battery as the master (ID 1) and connect it to the inverter. The remaining batteries act as slaves and should be connected in a daisy-chain using UTP communication cables, linking their communication ports in sequence as shown in Figure 5. Assign each slave battery a unique ID in ascending order (e.g., ID 2, ID 3, etc.) to ensure proper communication between all batteries and the inverter. Go to section 7.1 to learn how to change the ID.

Figure 5: HUSKY2 Comm Cable Connection Diagram

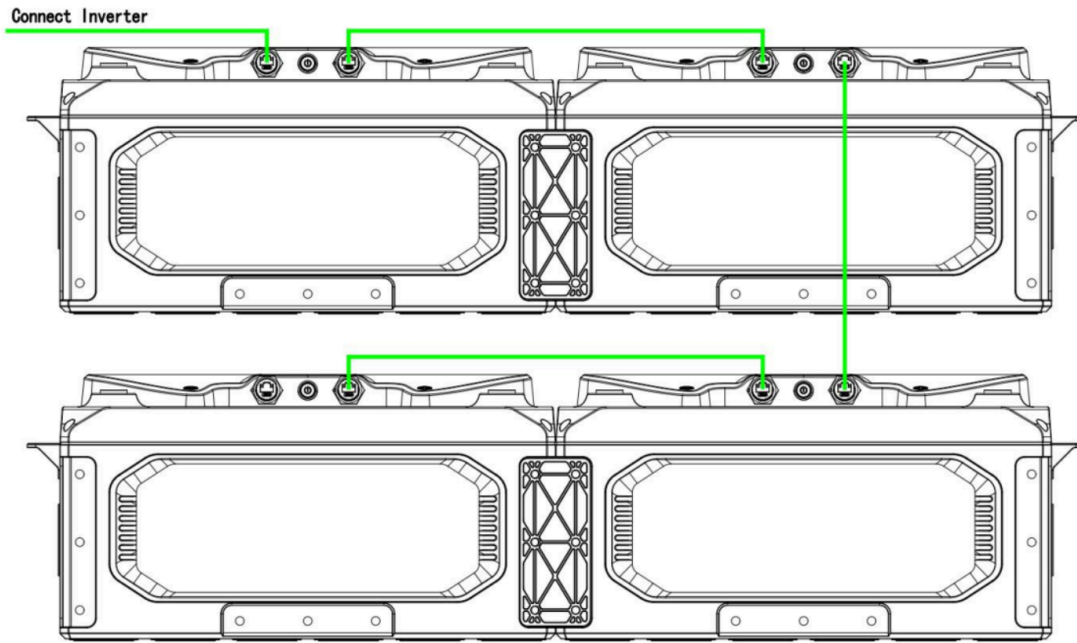

- ⑤ Connect the power cables in parallel. In other words, using the battery power ring terminal cables connect all the positives to each other, and the negatives to each negative connector, as shown in figure 6;

Figure 6: HUSKY2 Power Cable Connection Diagram

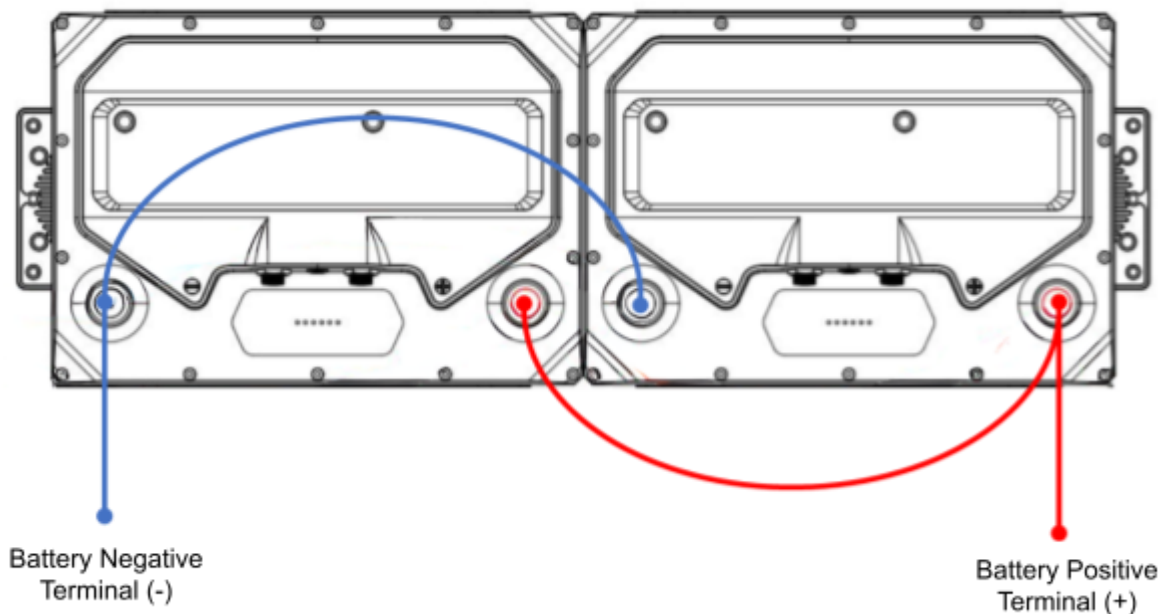

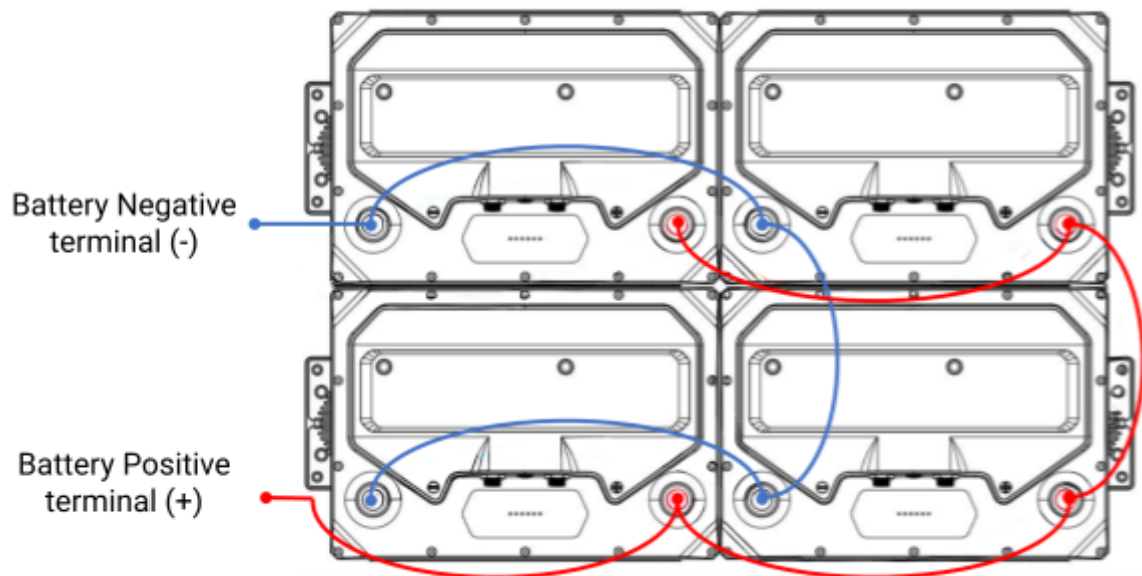

- ⑥ Connect the Battery Positive and Negative Terminal to your system (Inverter, charger, etc).

7. Battery Commissioning

If the HUSKY2 battery is connected to an inverter and you want to communicate the battery with the inverter, the battery address and protocol need to be configured through the Apple or Android Bluetooth. If communication is not needed, it can be directly connected to the inverter and select the Lead-Acid configuration when setting the inverter.

7.1. Battery Configuration

- ① Search for “BigBattery Husky 2” APP on the Apple Store (iOS users) or Play Store (Android users) and download it, as shown in figure 7

Figure 7: App Download

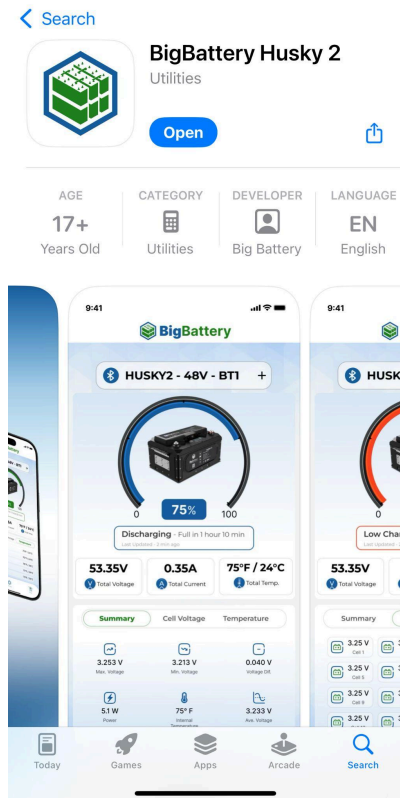

APP STORE

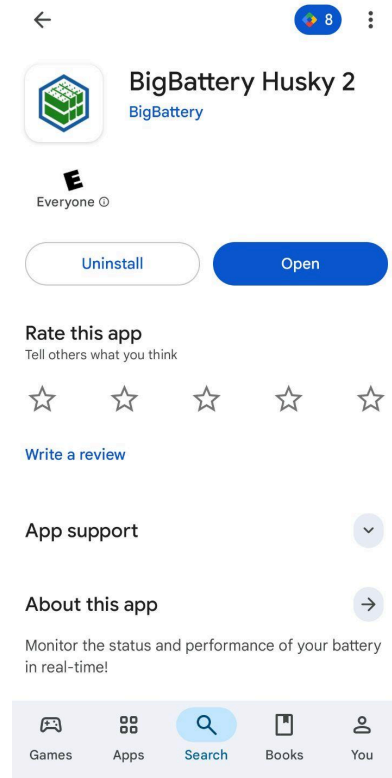

PLAY STORE

- ② Open the App and turn ON the HUSKY2 battery.
- ③ Connect the HUSKY 2 battery and the APP by Bluetooth. Search for batteries and connect it according to the battery's Bluetooth label (located at the left side of the battery); then click "Connect". It will display the battery information, as shown in Fig. 8.

Figure 8: App and HUSKY2 Battery Connection



APP STORE

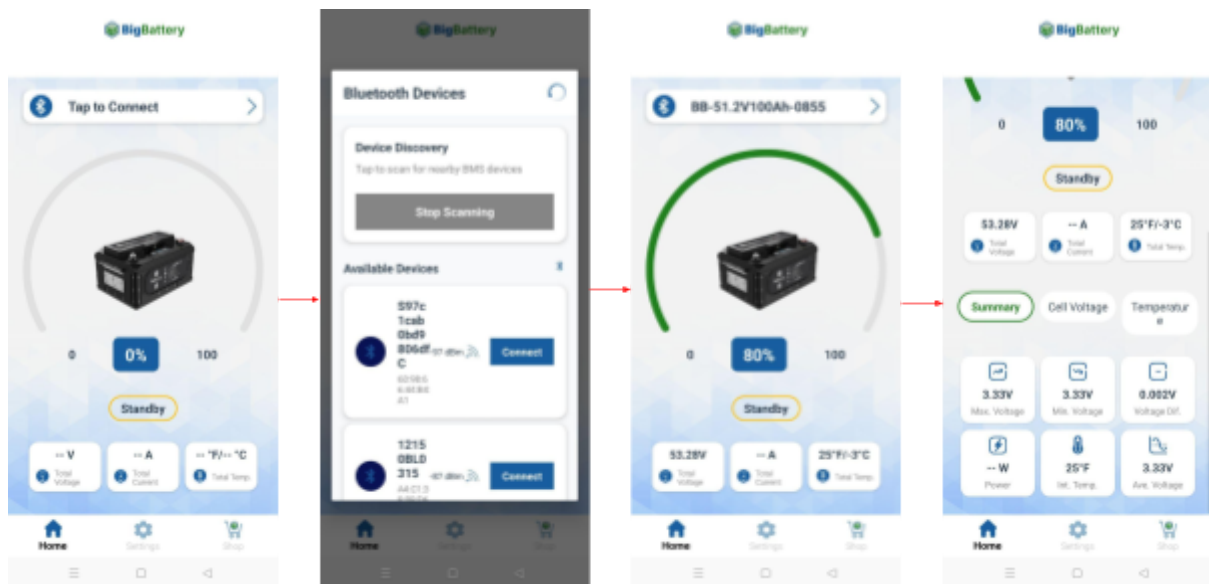

PLAY STORE

- ④ Select the ID address. Enter the settings interface. Click on "Module ID", select the appropriate ID (defaults=1). Make sure the battery connected to the inverter has Module ID "1". For systems with multiple batteries in parallel, designate one battery as the master (Module ID "1") and connect it to the inverter. The remaining batteries act as slaves. Assign each slave battery a unique ID in ascending order (e.g., ID 2, ID 3, etc.) to ensure proper communication between all batteries and the inverter.

Figure 9: Module ID selection

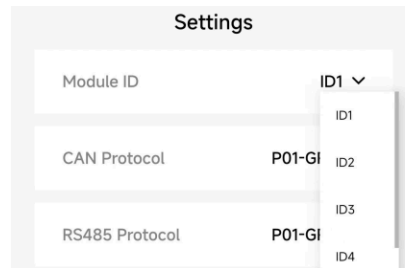

- ⑤ Click on "CAN Protocol" or "RS485 Protocol", select the corresponding protocol according to the connected inverter. **Power Cycle the battery after any change on the app.** All these steps are illustrated on Figure 10.

Figure 10: Protocol selection

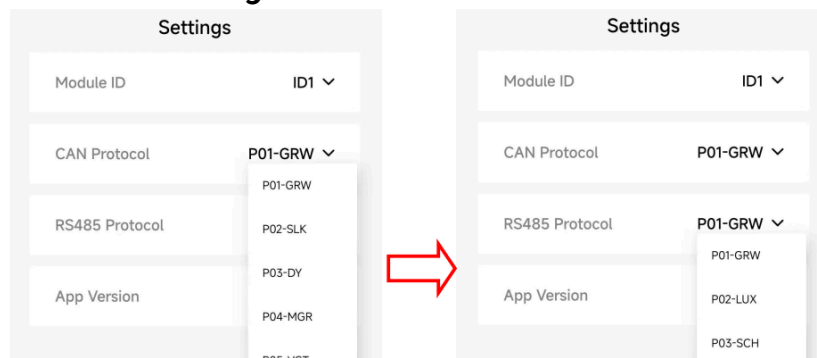

7.2. Supported Inverters

P0	RS485	P0	CAN
1	Growatt	1	Growatt
2	LuxPower	2	Sol-Ark
3	Schneider	3	Deye
4	Inhenergy	4	Megarevo
5	Voltronic	5	Victron
		6	LuxPower
		7	SMA
		8	Inhenergy
		9	Solis
		10	Afore
		11	Studer

Note: For the 12 and 24V Husky 2 Batteries, Victron is the only inverter compatible. For the 48V Husky 2, the previous list is applicable.

8. Battery Operation Guide

 **WARNING:** Before installing, make sure to review all the parameters listed on chapter 5.2.

8.1. Charging

- During the initial charging, monitor the battery's charge voltage to ensure it is within appropriate voltage limits.
- Only use the battery charger provided by BigBattery, or the inverter charging settings listed on section 5.2. Using non-recommended chargers may cause improper charging & damage the battery's capacity.
- The battery can be charged in freezing temperatures (-20°C / -4°F) due to a heating element. When charging is detected, heating will start until the battery temperature is above 0°C / 32°F and then charging will start.
- Use LiFePO4 batteries for "opportunity charging." Charge them whenever you can but do it with small amounts of energy. It's better to do this than using fast chargers. Fast charging can make the battery's life shorter.
- It is suggested to charge the battery when it has a minimum of 10-20% SOC. Deep discharge won't harm the battery's health, but the BMS requires some voltage to function properly.
- The Bulk/Absorb Voltage of an LFP battery is the same as the charging voltage. BigBattery products do not need Float Voltage, Equalize voltage or absorption time.

8.2 Discharging

- The battery can be fully discharged. Unlike lead-acid batteries, the Voltage of a lithium battery stays very constant during discharge, delivering the same amount of power and energy from 100% to 0% SOC.
- LFP batteries handle discharging to 0% safely, but shallower cycles offer benefits. Opting for 20% SOC, instead of 0%, extends the battery's lifespan to more than 6000 cycles.
- Do not discharge if the temperature is above 55 °C / 131 °F.
- You will see an apparent loss of capacity when discharging at below-freezing temperatures that reverses when the battery gets above freezing.
- The BMS will automatically shut down when the battery reaches a low voltage, so there's no need for manual intervention. Avoid over discharging by removing the load when the battery's discharge is done.

8.3 State of Charge

This is the Depth of Discharge of the HUSKY 2 family batteries:

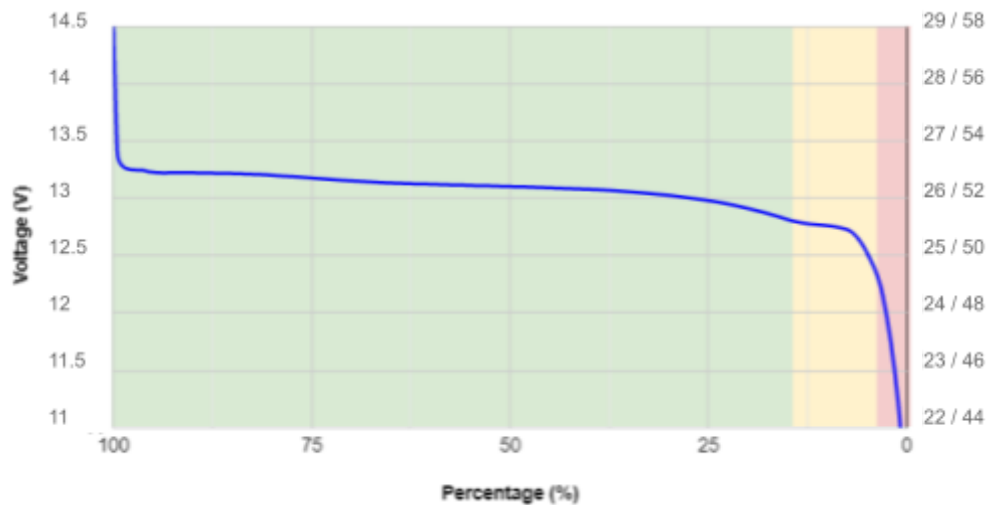

	Cycling in this zone will ensure a reasonable life expectancy
	Ocasionally this zone is OK
	Dropping into this zone can lock the battery. Could reduce lifespan.

8.3 Storage

- LFP batteries have an extremely low self-discharge rate, which makes long-term storage convenient. Storing a lithium battery for up to a year is not an issue, as long as it has some charge remaining before being placed in storage.
- Before storing lithium-ion batteries, charge them to at least 50% charging level. Do not store batteries that are fully discharged. In the case of a fully charged battery, it should be discharged to 80% before it is stored.
- If you need to store batteries for longer periods, be sure to simply disconnect all wires from them. That way there can not be any stray loads that slowly discharge the batteries.
- Make sure that you store the battery within the temperatures listed on section 5.2. Storing them at low temperatures is certainly much better than storage at high temperatures. The electrolyte in LiFePO4 cells does not contain any water, so even when it freezes it does not expand, and does not damage the cells. Just let the battery warm up a bit before you start discharging it again, which is OK at -4 °F (-20 °C).

This is the storage temperature that the batteries should be stored, and the charging intervals and methods to do so.

Storage Temperature	Charging Interval	Charging Method	Model
≤20°C	Once / 9M	28V 50A CC/CV Charging to 28V, cut-off current: 5A	24V HUSKY 2
20°C~30°C	Once / 6M		
30°C~40°C	Once / 3M		
≤20°C	Once / 9M	14V 50A CC/CV Charging to 14V, cut-off current: 5A	12V HUSKY 2
20°C~30°C	Once / 6M		
30°C~40°C	Once / 3M		

8.4 Extend the life of your Battery

The HUSKY 2 Battery is designed to last 10 years or more when used correctly. To ensure a proper battery operation, you must follow the previous listed instructions and battery parameters. In order to extend the lifespan of your battery, follow these recommendations.

- Avoid discharging the battery more than 80% Depth of Discharge (DOD) unless it is truly necessary.
- Keep the battery temperature under 95°F (35°C) and above 59°F (15°C).
- Keep battery charge and discharge current under 0.5 of the Capacity (C-rating)
- Never disassemble the battery, unless our tech support guides you. If the battery has any problems, contact us for assistance.
- Keep the battery away from excessive physical shocks or vibration. These can damage the battery's internal structure and hamper its operation.
- Dirty battery terminals can lead to improper flow of current during operation. Therefore, it is recommended that you clean the terminals while installing the battery pack.

9. Service

9.1 Troubleshooting

No.	Error	Description	Solution
1	Communication failure with inverter	Communication port connection error or battery ID setting error	Check connection. Refer Chapter 7. Battery Commissioning
2	No DC output	Battery is off or low voltage	Turn ON or charge the battery
3	Power supply time is too short	Battery capacity lack or not fully charged	Fully Charge the battery. Maintenance or replacement
4	Battery can't be charged fully	Power system DC output voltage falls below the minimum charge voltage	Regulating DC output voltage of power supply to battery suitable charging voltage
5	ALM LED always lights	Power line connection short circuit	Disconnect the power cable and check all cables
6	The battery output voltage is unstable	Battery management system do not operate normally	Press the switch to restart the battery
7	The charge and discharge capacity is insufficient	Unbalance voltage with cell	Examine/balance the cell
8	Unable to charge and discharge	BMS or cell/temperature sensor damaged	Maintenance or replacement
9	Different SOC value of batteries in parallel	Normal phenomenon	No operation
10	Alarm is ON	Current Protection	Charging or Discharging Current is too high and needs to be reduced.
11	Alarm is ON	Over Temperature	Turn off the battery and cool down the location if possible.
12	Alarm is ON	End-Off Voltage	Charge the battery

9.2 Maintenance

Item	Maintenance	Maintenance Intervals
Power Cables	Check whether there is mechanical damage to the power cable and whether the terminal insulation sleeve has fallen off; if there is such a phenomenon, please turn off the machine & carry out maintenance or replacement	Once every 6 months
	Check if the power cable is loose; if there is any sign of looseness, use a standard torque wrench to tighten it	
	Check the system for loose screws or discoloration of the copper bus bar; if the screws are loose, please tighten them with a standard torque wrench; if the copper bus bar is discolored, please contact the manufacturer for after-sales replacement	
Comm Cables	Check whether the parallel communication cable terminal is loose, if it is loose, re-tighten it	Once a year
	Check whether the color of the communication cable has obvious discoloration, if discoloration, please shut down the machine to replace the communication cable	
Cabinet	Check the cleanliness of the front door, back door and battery module inside the cabinet, if there is obvious dusty, please clean up in time.	Once 6-12 months
System Running Status	Check if all parameters are normal when the system is running (voltage, current, temperature, etc.)	Once every 6 months
	Check whether the main core components of the system are normal, including system switches, contactors, etc. are normal	
	Check whether the system air inlet and outlet, air ducts are normal, if there is blockage and congestion, need to clean up in time	
Charge and Discharge Maintenance	Use light load & shallow charge/discharge to check whether the SOC, SOH of the battery is normal (using the upper computer software to read); it's recommended that the depth of discharge and charge/discharge power do not exceed 20% of the rated value	Once every 6 months

10. Recycling

Lithium iron phosphate batteries are potentially dangerous and shouldn't be tossed in the trash. Many websites and organizations can recycle them for free. If you're in the U.S. or anywhere globally, search for "Lithium Battery Disposal Near Me" online. Numerous places can safely dispose of these batteries. Make sure to call first to confirm they're open. If you can't find a safe disposal option, contact our customer service team instead of improperly disposing of the battery. We can take care of recycling your batteries for you.

11. Warranty & Returns

In the unlikely event you are having an issue with one of our batteries we have developed a straightforward warranty & return policy which is detailed in the following link:

https://bigbattery.com/policies/?gad_source=1&gclid=CjwKCAiA6KWvBhAREiwAFPZM7viG8eXNc1fNpm99vxwVI_ptHceLQp0xSAZyxsQD0iizXRI4kTa8ARoCPLqQAvD_BwE#warranty

For more information and support please visit our website and reach us at:

BigBattery LLC.
Technical Support Team
Support@BigBattery.com
(818) 280-3091
400 Maple St.
Commerce, TX 75428